

MS1-R Series Servo Motor Installation Guide



Industrial
Automation



Intelligent
Elevator



New Energy
Vehicle



Industrial
Robot



Rail
Transit



Data code P500005407A02

Preface

Introduction

Thank you for purchasing the MS1-R series servo motor.

As the latest generation of servo motors developed by Inovance, the MS1-R series servo motor carries a power range from 0.05 kW to 7.5 kW, with flange sizes ranging from 40 mm to 180 mm. It offers multiple types of inertia and speed configurations, with different types of encoders configured.

It is used for accurate position control, speed control, and torque control in industries including semiconductors, lithium batteries, silicon, machine tools, mobile phones, printing and packaging, pharmacy, textile, and display. This manual provides installation instructions, mechanical/electrical installation, and maintenance of the motor.

Contact Inovance for detailed information on the motor function and performance.

Documents provided by Inovance are subject to change without notice due to continuous product improvement.

Note

- The drawings in the user guide are sometimes shown without covers or protective guards. Remember to install the covers or protective guards as specified first, and then perform operations in accordance with the instructions.
- The drawings in the user guide are shown for descriptions only and may not match the product you purchased.
- The user guide is subject to change without notice due to product upgrade, specification modifications as well as efforts to improve the accuracy and convenience of the user guide.

More documents

Document Name	Data Code	Description
MS1-R Series Servo Motor Selection Guide	PS00004605	Describes product information, general specifications, motor selection, cable selection, certification categories and standards of the product.
MS1-R Series Servo Motor Installation Guide	PS00005407	Describes the installation of the motor, including motor installation flowcharts, wiring, unpacking and handling, mechanical installation, electrical installation.

Revision history

Date	Version	Description
December 2023	A02	Updated chapter Installation Environment.
November 2023	A01	<ul style="list-style-type: none">• Updated chapter Installing the Motor• Updated chapter Installation Environment.
March 2022	A00	First release

Access to the Guide

This guide is not delivered with the product. You can obtain the PDF version in the following ways:

- Visit <http://www.inovance.com>, go to Support > Download, search by keyword, and then download the PDF file.
- Scan the QR code on the product with your smart phone.
- Scan the QR code below to install the app, where you can search for and download manuals.



Warranty

Inovance provides warranty service within the warranty period (as specified in your order) for any fault or damage that is caused by proper operation of the user. Repair work will be charged after the warranty period expires.

Within the warranty period, maintenance will be charged for the following damage:

- Damage caused by operations not following the instructions in the user guide
- Damage caused by fire, flood, or abnormal voltage
- Damage caused by unintended use of the product
- Damage caused by use beyond the specified scope of application of the product
- Damage or secondary damage caused by force majeure (natural disaster, earthquake, and lightning strike)

The maintenance fee is charged according to the latest Price List of Inovance. If otherwise agreed upon, the terms and conditions in the agreement shall prevail.

For details, see the Product Warranty Card.

Table of Contents

Preface	1
Safety Precautions	5
1 Installation Instructions	12
2 Installation Flowchart	13
3 Preparation	14
3.1 Installation Environment	14
3.2 Requirements on Installation Personnel	15
3.3 Installation Tools	16
3.4 Preparing Cables	17
4 Unpacking and Handling	20
4.1 Unpacking	20
4.2 Handling	21
4.3 Storage	23
5 Mechanical Installation	25
5.1 Safety Precautions	25
5.2 Pre-Installation Inspection	27
5.3 Installing the Motor	27
5.4 Post-Installation Inspection	31
6 Electrical Installation	33
6.1 Safety Precautions	33
6.2 Pre-wiring Inspection	34
6.3 Connecting the Power Cable	35
6.4 Connecting the Encoder Cable	38
6.5 Connector Operations	42
6.6 Post-Installation Inspection	44
7 Routine Maintenance	46
7.1 Regular Inspection	46
7.1.1 Regular Inspection	46
7.1.2 Regular Maintenance	46
8 Replacing Components	48
9 Appendix	49
9.1 Commissioning	49
9.2 Troubleshooting	50

9.3 Disposal 51

Safety Precautions

Safety Disclaimer

- This section explains the safety precautions that need to be observed to use this product correctly. Before using this product, please read the user guide and correctly understand the relevant information of safety precautions. Failure to comply with the safety precautions may result in death, serious injury, or equipment damage.
- "CAUTION", "WARNING", and "DANGER" items in the user guide only indicate some of the precautions that need to be followed; they just supplement the safety precautions.
- Use this equipment according to the designated environment requirements. Damage caused by improper use is not covered by warranty.
- Inovance shall take no responsibility for any personal injuries or property damage caused by improper use.

Safety Levels and Definitions



DANGER

Indicates that failure to comply with the notice will result in death or severe personal injuries.



WARNING

Indicates that failure to comply with the notice may result in death or severe personal injuries.



CAUTION

Indicates that failure to comply with the notice may result in minor or moderate personal injuries or equipment damage.

Safety Precautions

- Drawings in the user guide are sometimes shown without covers or protective guards. Remember to install the covers or protective guards as specified first, and then perform operations in accordance with the instructions.
- The drawings in the user guide are shown for illustration only and may be different from the product you purchased.

Unpacking



WARNING

- Do not install the equipment if you find damage, rust, or signs of use on the equipment or accessories upon unpacking.
- Do not install the equipment if you find water seepage or missing or damaged components upon unpacking.
- Do not install the equipment if you find the packing list does not conform to the equipment you received.

 CAUTION

- Check whether the packing is intact and whether there is damage, water seepage, dampness, and deformation before unpacking.
- Open the package in sequence. Violent beating is prohibited.
- Check whether there is damage, rust, or injuries on the surface of the equipment and equipment accessories when unpacking.
- Check whether the package contents are consistent with the packing list after unpacking.

Storage and Transportation

 WARNING

- Large-scale or heavy equipment must be transported by qualified professionals using specialized hoisting equipment. Failure to comply may result in personal injuries or equipment damage.
- Before hoisting the equipment, ensure the equipment components such as the front cover and terminal blocks are secured firmly with screws. Loosely-connected components may fall off and result in personal injuries or equipment damage.
- Never stand or stay below the equipment when the equipment is being hoisted by the hoisting equipment.
- When hoisting the equipment with a steel rope, ensure the equipment is hoisted at a constant speed without suffering from vibration or shock. Do not turn the equipment over or let the equipment stay hanging in the air. Failure to comply may result in personal injuries or equipment damage.

 CAUTION

- Handle the equipment with care during transportation and mind your steps to prevent personal injuries or equipment damage.
- When carrying the equipment with bare hands, hold the equipment casing firmly with care to prevent parts from falling. Failure to comply may result in personal injuries.
- Store and transport the equipment based on the storage and transportation requirements. Failure to comply will result in equipment damage.
- Avoid storing or transporting the equipment in environments with water splash, rain, direct sunlight, strong electric field, strong magnetic field, and strong vibration.
- Avoid storing the equipment for more than 3 months. Long-term storage requires stricter protection and necessary inspections.
- Pack the equipment strictly before transportation. Use a sealed box for long-distance transportation.
- Never transport the equipment with other equipment or materials that may harm or have negative impacts on this equipment.
- It is normal that the flat key installed on the output shaft of the motor is easy to fall, and it does not affect the use of customers.

Installation

**DANGER**

- The equipment can be operated by well-trained and qualified professionals only. Non-professionals are not allowed.

**WARNING**

- Read through the user guide and safety instructions before installation.
- Do not install this equipment in places with strong electric or magnetic fields.
- Before installation, check that the mechanical strength of the installation site can bear the weight of the equipment. Failure to comply will result in mechanical hazards.
- Do not wear loose clothes or accessories during installation. Failure to comply may result in an electric shock.
- When installing the equipment in a closed environment (such as a cabinet or casing), use a cooling device (such as a fan or air conditioner) to cool the environment down to the required temperature. Failure to comply may result in equipment over-temperature or a fire.
- Do not retrofit the equipment.
- Do not fiddle with the bolts used to fix equipment components or the bolts marked in red.
- When the equipment is installed in a cabinet or terminal device, the cabinet or terminal device must be equipped with enclosures for fire, electric and mechanical protection. The IP rating must meet IEC standards and local laws and regulations.
- Before installing devices with strong electromagnetic interference, such as a transformer, install a shielding device for the equipment to prevent malfunction.
- Install the equipment onto an incombustible object such as a metal. Keep the equipment away from combustible objects. Failure to comply will result in a fire.

**CAUTION**

- Cover the top of the equipment with a piece of cloth or paper during installation. This is to prevent unwanted objects such as metal shavings, oil, and water from falling into the equipment and causing faults. After installation, remove the cloth or paper on the top of the equipment to prevent over-temperature caused by poor ventilation due to blocked ventilation holes.
- Resonance may occur when the equipment operating at a constant speed executes variable speed operations. In this case, install the vibration-proof rubber under the motor frame or use the vibration suppression function to reduce resonance.
- It is normal that the flat key installed on the output shaft of the motor is easy to fall, and it does not affect the use of customers.

Wiring

 DANGER

- Equipment installation, wiring, maintenance, inspection, or parts replacement must be performed only by professionals.
- Before wiring, cut off the power supply of all equipment. Residual voltage exists after power cut-off. Therefore, wait at least the time designated on the equipment warning label before further operations. Measure the DC voltage of the main circuit and make sure it is below the safe voltage, otherwise there will be the danger of electric shock.
- Do not perform wiring, remove the equipment cover, or touch the circuit board with power ON. Failure to comply will result in an electric shock.
- Check that the equipment is grounded properly. Failure to comply will result in an electric shock.

 WARNING

- Do not connect the input power supply to the output end of the equipment. Failure to comply will result in equipment damage or even a fire.
- When connecting a drive to the motor, check that the phase sequences of the drive and motor terminals are consistent to prevent reverse motor rotation.
- Cables used for wiring must meet cross sectional area and shielding requirements. The shield of the cable must be reliably grounded at one end.
- Fix the terminal screws with the tightening torque specified in the user guide. Improper tightening torque may overheat or damage the connecting part, resulting in a fire.
- After wiring is done, check that all cables are connected properly, with no screws, washers, or exposed cables left inside the equipment. Failure to comply may result in an electric shock or equipment damage.





 CAUTION



- During wiring, follow the proper electrostatic discharge (ESD) procedures, and wear an antistatic wrist strap. Failure to comply will damage the equipment or the internal circuits of the equipment .
- Use shielded twisted pairs for the control circuit. Connect the shield to the grounding terminal of the equipment for grounding purpose. Failure to comply will result in equipment malfunction.
- It is normal that the flat key installed on the output shaft of the motor is easy to fall, and it does not affect the use of customers.

Power-on

 DANGER



- Before power-on, check that the equipment is installed properly with reliable wiring and the motor can be restarted.
- Check that the power supply meets equipment requirements before power-on to prevent equipment damage or a fire.
- After power-on, do not open the cabinet door or protective cover of the equipment, touch any terminal, or disassemble any unit or component of the equipment. Failure to comply will result in an electric shock.





<div data-bbox="181 130 325 178" style="border: 1px solid black; padding: 2px;">  WARNING </div> <ul style="list-style-type: none"> • Perform a trial run after wiring and parameter setting to ensure the equipment operates safely. Failure to comply may result in personal injuries or equipment damage. • Before power-on, make sure that the rated voltage of the equipment is consistent with that of the power supply. Failure to comply may result in a fire. • Before power-on, check that no one is near the equipment, motor, or machine. Failure to comply may result in death or personal injuries.
Operation
<div data-bbox="181 411 325 459" style="border: 1px solid black; padding: 2px;">  DANGER </div> <ul style="list-style-type: none"> • The equipment must be operated only by professionals. Failure to comply will result in death or personal injuries. • Do not touch any terminals or disassembly any part of the equipment during operation. Failure to comply will result in an electric shock.
<div data-bbox="181 598 325 646" style="border: 1px solid black; padding: 2px;">  WARNING </div> <ul style="list-style-type: none"> • Do not touch the equipment casing, fan, or resistor with bare hands to feel the temperature. Failure to comply may result in personal injuries. • Prevent metal or other objects from falling into may the equipment during operation. Failure to comply may result in a fire or equipment damage. • It is normal that the flat key installed on the output shaft of the motor is easy to fall, and it does not affect the use of customers.
Maintenance
<div data-bbox="181 874 325 922" style="border: 1px solid black; padding: 2px;">  DANGER </div> <ul style="list-style-type: none"> • Equipment installation, wiring, maintenance, inspection, or parts replacement must be performed only by professionals. • Do not maintain the equipment after power-on. Failure to comply will result in an electric shock. • Before maintenance, cut off all the power supplies of the equipment and wait for at least the time designated on the equipment warning label. • When using a permanent magnet motor, the motor terminals will generate induced voltage during rotation even after the equipment power supply is off. Do not touch the motor terminals. Failure to comply will result in an electric shock.
<div data-bbox="181 1189 325 1236" style="border: 1px solid black; padding: 2px;">  WARNING </div> <ul style="list-style-type: none"> • Perform routine and periodic inspection and maintenance on the equipment according to maintenance requirements and keep a maintenance record. • It is normal that the flat key installed on the output shaft of the motor is easy to fall, and it does not affect the use of customers.
Repair

<div style="border: 1px solid black; padding: 2px; display: inline-block;">  DANGER </div> <ul style="list-style-type: none"> • Equipment installation, wiring, maintenance, inspection, or parts replacement must be performed only by professionals. • Do not repair the equipment with power ON. Failure to comply will result in an electric shock. • Before inspection and repair, cut off all the power supplies of the equipment and wait for at least the time designated on the equipment warning label.
<div style="border: 1px solid black; padding: 2px; display: inline-block;">  WARNING </div> <ul style="list-style-type: none"> • When the fuse is blown or the circuit breaker or earth leakage current breaker (ELCB) trips, wait for at least the time designated on the equipment warning label before power-on or further operations. Failure to comply may result in death, personal injuries, or equipment damage. • When the equipment is faulty or damaged, the troubleshooting and repair work must be performed by professionals that follow the repair instructions, with repair records kept properly. • Replace quick-wear parts of the equipment according to the replacement instructions. • Do not use damaged equipment. Failure to comply may result in death, personal injuries, or severe equipment damage. • After the equipment is replaced, check the wiring and set parameters again. • It is normal that the flat key installed on the output shaft of the motor is easy to fall, and it does not affect the use of customers.
Disposal
<div style="border: 1px solid black; padding: 2px; display: inline-block;">  WARNING </div> <ul style="list-style-type: none"> • Dispose of retired equipment in accordance with local regulations and standards. Failure to comply may result in property damage, personal injuries, or even death. • Dispose of and recycle the retired equipment by following industry waste disposal standards to avoid environmental pollution.

Safety Labels

For safe equipment operation, comply with the safety signs on the equipment, and do not damage or remove the safety labels. Safety signs are described as follows:

Safety Label	Description
	Read the user guide before installation and operation.
	Reliably ground the system and equipment!

Safety Label	Description
	Indicates risks of danger.
	Indicates risks caused by high voltage.
	Indicates risks of personal injury caused by the machine.
	Indicates risks caused by high temperature.
	Do not strike the motor.

1 Installation Instructions

- Observe the installation direction described in this chapter. Failure to comply may result in equipment fault or damage.
- Do not install or operate damaged or defective equipment. Failure to comply will result in personal injury.
- Do not install the equipment in environments exposed to water splashes or corrosive gases. Failure to comply will result in equipment fault.
- Do not install the equipment near inflammable gases or combustible objects. Failure to comply will result in a fire or electric shock.
- Install the equipment inside a fire-proof cabinet that provides electrical protection. Failure to comply may result in a fire.
- Do not put heavy objects on the equipment. Failure to comply may result in personal injury or equipment damage.
- Do not impose large impact on the equipment. Failure to comply may result in equipment damage.

2 Installation Flowchart

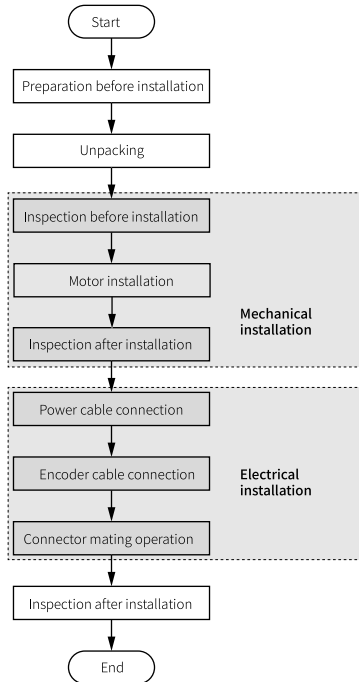

Figure 2-1 Installation flowchart

Note

The illustration presents the recommended installation procedure. You can adjust the procedure as appropriate.

3 Preparation

3.1 Installation Environment

Item	Requirement
Altitude	Standard: 1000 m and below (Derating is required for altitudes above 1000 m. See section "Altitude-based Derating Curve" in MS1-R Series Servo Motor Selection Guide for details.)
Ambient temperature	0°C to 40°C (non-frozen)
Storage temperature	-20°C to +60°C (non-frozen)
Ambient humidity	20% to 80% RH (without condensation)
Storage humidity	20% to 80% RH (without condensation)
Vibration level	V15 ^[1]
Vibration resistance ^{[2][4]}	Vibration acceleration (flange face as standard), 49 m/s ² in radial direction and 24.5 m/s ² in axial direction
Shock resistance ^{[3][4]}	490 m/s ² (flange side as standard), number of shocks: 2
IP rating of enclosure	After wiring is done, the overall IP rating of the motor is as follows: IP67 (excluding shaft opening and flying leads type motor connectors)
Installation location	<ul style="list-style-type: none"> • Install the servo motor in an environment free from corrosive or flammable gases or combustible objects, such as hydrogen sulfide, chlorine, ammonia, sulphur gas, chlorinated gas, acid, soda, and salt. • Use the motor with oil seal in places with grinding fluid, oil mist, iron powders or cuttings. • Away from heating sources such as a heating stove • Do not use the motor in an enclosed environment. Running in an enclosed environment will lead to motor overtemperature, which shortens its service life. • The X-RAY absorbed dose of the storage site should be lower than 100 rad (silicone)/25 rad (air).

Note

- [1] Vibration grade V15 indicates that the vibration amplitude is lower than 15 μm when the motor is operating at rated speed.
 - [2] For a servo motor shaft mounted horizontally, the vibration resistance level in the up/down, left/right, and front/rear directions is shown in the preceding table.
 - [3] For a motor shaft mounted horizontally, the impact resistance level in the up and down directions is shown in the preceding table.
 - [4] The vibration intensity applied on the motor is affected by the transmission structure, alignment accuracy, mounting conditions, and external vibration. These factors may enhance the vibration applied on the motor. When the maximum allowable vibration limit is exceeded, the motor may fail. Therefore, take necessary measures to limit resonance.
-

3.2 Requirements on Installation Personnel

The product/system described in this manual may be operated only by personnel qualified for the specific task in accordance with the relevant documentation, in particular its warning notices and safety instructions. Qualified personnel can identify the risks of the product/system and prevent possible dangers.

All the mechanical operations may be executed only by trained professionals that not only familiar with the installation position, mechanical installation, troubleshooting/maintenance, but also meet the following requirements:

- Received safety training and passed related examinations or received training on mechanical operations (such as mechanical engineers or electrical engineers)
- Familiar with electrical equipment and basic mechanical characteristics and installation requirements of the motor
- Physically qualified for mechanical operations
- Familiar with this manual especially all the safety precautions

All the electrical operations may be executed only by trained professionals that not only familiar with the installation position, mechanical installation, troubleshooting/maintenance, but also meet the following requirements:

- Received professional electrical training (such as electrical engineers)
 - Familiar with this manual especially all the safety precautions
-

Note

Do not touch live parts. Failure to comply can lead to severe injury or even death.

- Operations on the electrical equipment can be performed by professionals only.
 - Observe local safety regulation during operation.
-

3.3 Installation Tools

Tools and auxiliary materials needed during installation:

- Standard tools: gloves, Phillips screwdriver, straight screwdriver, Allen wrench, torque wrench
- Torque wrench or screwdriver with self-locking function
- Used to disassemble the needle-nose pliers of the shaft key.
- Used to machining the crimping plier of connectors.
- Vernier caliper, micrometer, tensometer
- Slip-proof gloves
- Detergent
- The 180-flange motor is equipped with two M8 eyebolts as standard.

Note

Improper screwdrivers or tightening torque may damage the screws on the equipment.

- Use a screwdriver that matches the screw head.
 - Tighten the screws with specified tightening torque.
 - Use a torque wrench or sensor with dynamic torque and mechanical high-precision screwdriver with speed limit.
-

3.4 Preparing Cables

System composition

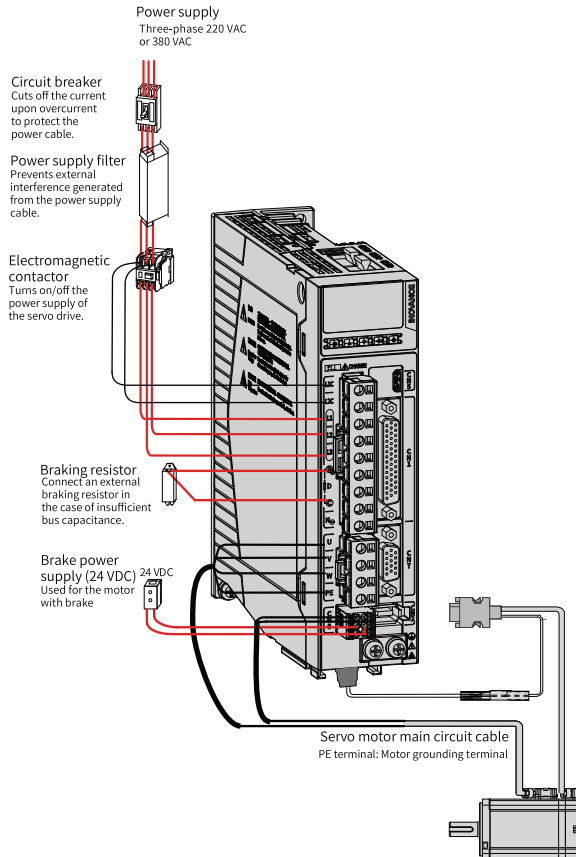

Figure 3-1 System wiring diagram

Use cables prefabricated by Inovance (excluded in the scope of delivery). These cables can be shorten the installation time and improve the operation safety.

Preparing cables

Cables on the motor side that connected to the servo drive include the power cable and encoder cable. These two types of cables must be used together.

S6-L-M 0 0 0 - 3.0 - T

① ② ③ ④ ⑤ ⑥

<p>① Cable type S6-L-B/M: Motion control power cable B: With brake M: Without brake</p>	<p>③ Cross sectional area (mm²) 0: Flange sizes 25/40/60/80 1: Flange sizes 100/130/180 2: Flange size 180 (motors of 4.4 kW and above)</p>	<p>⑤ Cable Length (m) 3.0: 3 m 5.0: 5 m 10.0: 10 m</p>
<p>② Connector type at drive side 0: U-shaped cable lug 1: Needle-shaped cable lug</p>	<p>④ Connector type at motor side 0: 6-core plastic connector 1: 9-core aviation connector 2: 6-core aviation connector 7: SDC-06T series aviation connector (front outlet) 8: SDC-06T series aviation connector (rear outlet)</p>	<p>⑥ Special requirements T: Flexible cable TS: Shielded flexible cable</p>

S6-L-P 0 0 0 - 3.0 - T

① ② ③ ④ ⑤ ⑥

<p>① Cable type S6-L-P: Motion control encoder cable</p>	<p>③ Encoder 1: Communication-type incremental encoder 2: Communication-type multi-turn absolute encoder</p>	<p>⑤ Cable Length (m) 3.0: 3 m 5.0: 5 m 10.0: 10 m</p>
<p>② Connector type at drive side 0: DB9 1: USB</p>	<p>④ Connector type at motor side 0: 9-core plastic connector 1: 9-core aviation connector 4: SDC-06T series aviation connector (front outlet) 5: SDC-06T series aviation connector (rear outlet)</p>	<p>⑥ Special requirements T: Flexible cable TS: Shielded flexible cable</p>

- Select the cables based on the selection guide. Check whether the cables are intact. If there is sign of damage or loose connection, replace the cables immediately. Failure to comply may affect operation of the device.
- Do not use customized cables. If you do need such cables, contact Inovance.





- If you need to replace or solder the cable connectors, check the pin assignment based on the manual. If the cable shield is damaged, the device may be subjected to interference.

4 Unpacking and Handling

4.1 Unpacking

Precautions for Unpacking

- Pay attention to the handling icons on the package after receiving the motor.
Handling icons and definitions:

Icon	Description	Icon	Description
	Upwards		Damp-proof
	Fragile		No stacking

- Check the integrity of the deliverables.
 - Check whether the deliverables are consistent with the order.
 - If there is any obvious damage caused during transportation, report it to the carrier immediately.
 - If there is any part missing, report it to Inovance agent.
 - The sheet Motor Safety Precautions is within the scope of delivery, keep it properly for future use.

Note

- Claims exceeding the time limit will not be accepted.
- Do not operate on damaged components.
- Observe local regulations during packing and handling the motor.

Unpacking Inspection

Check the following items upon unpacking.

Item	Description
Check whether the delivered product is consistent with your order.	Check whether the motor model and specifications comply with your order. Note: Check whether the packing box is intact. If the packing box is damaged, contact your supplier immediately.
Check whether the product is intact.	Check whether the product delivered is in good condition. If there is any missing or damage, contact Inovance or your supplier immediately.

4.2 Handling

Use proper tools during handling and packaging to prevent damage caused by improper operations. Operating a damaged motor may damage the winding, bearing, or even the whole system.

Hoisting and handling the motor (flange size lower than 180 mm) with dedicated tools

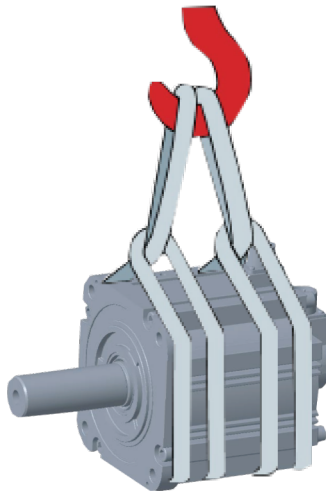

Figure 4-1 Hoisting and handling the motor with dedicated tools

 **Caution**

- The motor may fall if an improper hoisting mode is used or the hoisting tool is used improperly, leading to death or serious personal injury.
 - The load-carrying capacity of the hoisting tool must be able to bear the weight of the motor.
 - Install the hoisting tool to the motor as shown in section Hoisting and Handling the Motor with Hoisting Tool.
 - Do not hold the motor or motor shaft with bare hands during handling. Failure to comply may lead to personal injury or fault.
-

Hoisting and handling the motor (flange size not lower than 180 mm) with dedicated tools



Figure 4-2 Hoisting and handling the motor through the eyebolt



- The motor may fall if the suspension point is incorrect or is not used, which may lead to serious personal injury or even death.
 - For large-scale motors, hoist and handle the motor through the two eyebolt screws on the bearing end cover.
 - The pull direction cannot exceed 45°.
 - Screw down the eyebolt screws manually with a tightening torque of 6 N·m to 8 N·m. The screw hole may be damaged in case of excessively high tightening torque imposed by tools.
 - Do not use deformed or damaged eyebolt screws.
 - No external force is allowed in the direction perpendicular to the eyebolt plane.
-

Laying down the motor

1. Lay the motor on a fixed and flat surface.
2. Take measures to prevent the motor from operating unexpectedly.



If the motor has not been fixed properly after being put down, it may move accidentally and result in personal injury.

- Fix the motor properly after putting it down.
 - Release the crane device after fixing the motor.
-

4.3 Storage

Pack the motor into the original package if possible. Apply protective coating on the exposed shaft end, sealing components, and flange face. Store the motor in a dry, dust-free, and vibration-free place indoors. This is to prevent the motor from being affected by extreme weather factors. The motor can be stored for at most two years in temperatures between -20°C to +60°C. An excessively long storage time can affect the characteristics of the lubricating grease on the roller bearing. Equipment damage caused by failure to comply with preceding instructions is not covered by warranty.

The place where the motor is stored for more than six months must meet the following requirements.

Table 4-1 Storage environment conditions

Item	Description
Climatic environmental condition	-20°C to +60°C
Maximum relative humidity	<60% (without condensation)
Mechanical environmental condition	Stable and vibration-free; $V_{\text{valid}} < 0.2 \text{ mm/s}$ X-RAY absorbed dose <100 rad (silicone)/ <25 rad (air)

Check the motor every six months:

- Check whether the motor is damped by measuring the insulation resistance (measuring voltage: 500 VDC).
- Check whether connectors and fasteners are corroded and whether sealing parts are intact.
- Perform necessary maintenance.
- Check the desiccant state and replace it timely.
- Make a record of the storage operation. Release the motor before putting it into operation.

The insulation resistance is closed related to the temperature. If the insulation resistance is excessively low after long-term storage, take drying measures on the motor, such as drying the motor with hot air.

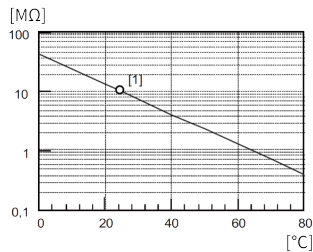

Figure 4-3 Insulation resistance and temperature curve

Note

The following environment conditions may easily lead to water condensation:

- Dramatic temperature change;
- Direct sunlight;
- High temperature during storage;
- Put a desiccant into the package and avoid preceding conditions.

5 Mechanical Installation

5.1 Safety Precautions

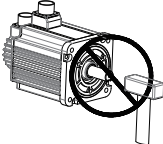
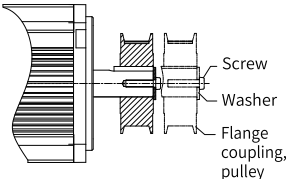
Item	Description
Rust-proof treatment	Wipe up the anti-rust agent applied at the motor shaft extension before installing the servo motor, and then take rust-proof measures.
Shaft extension installation	<p>Do not strike the shaft extension during installation. Failure to comply can damage the internal encoder.</p> 
	<ul style="list-style-type: none"> • When you need to install related accessories to the shaft extension, press-in the accessories through mounting screws and washers to the shaft extension. Do not strike on the bearing. • To remove related accessories, you can use a thruster or similar to prevent the bearing from being damaged. • To ensure safety, install a protective cover or a similar device in the rotary area. 

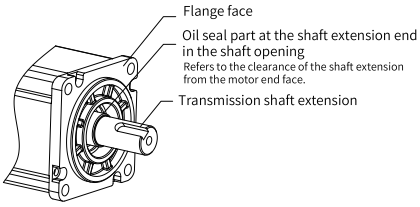
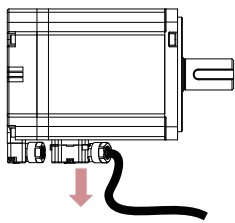
Item	Description
Installation direction	The servo motor can be installed horizontally or vertically.
Measures against oil and moisture	<ul style="list-style-type: none"> • The oil seal is only dust-proof. • Do not submerge the motor/cable in water or oil. • Confirm the IP level of the servo motor when using it in a place with water drops. (except for the shaft opening) <div style="text-align: center;">  </div> <ul style="list-style-type: none"> • Install the motor with its connecting terminals facing downwards (as shown in the following figure) when the motor is to be used in a place with liquid. This is to prevent the liquid from flowing into the motor along the cable. <div style="text-align: center;">  </div> <ul style="list-style-type: none"> • In environments where the shaft opening is exposed to oil drops, use a servo motor with an oil seal. • Observe the following requirements when using the servo motor with an oil seal: <ul style="list-style-type: none"> ■ Make sure the oil level is lower than the oil seal lip during use. ■ Prevent oil accumulation on the oil seal lip when the motor is installed vertically upward. ■ For a motor with oil seal, if the output shaft is installed upwards, the engine oil may enter the motor. Ensure that the direction is suitable for operation conditions. ■ For a servo motor with reducer, leave a small amount of oil on the lip for lubrication. When the oil seal is submerged in the oil, the oil may enter the motor, leading to motor faults. As the shaft opening is not water-proof or oil-proof, take proper measures to prevent water drops or cutting oil from entering the motor, leading to motor faults.

5.2 Pre-Installation Inspection

Check the following items before installation.

Table 5-1 Inspection Checklist

No.	Description	Checked
1	The delivered product is consistent with your order.	<input type="checkbox"/>
2	No deformation or cracks are present on the casing.	<input type="checkbox"/>
3	All screws are in position and tightened.	<input type="checkbox"/>
4	The signal terminal is free from fracture, foreign objects and bent pins.	<input type="checkbox"/>
5	All the necessary components in the drive system are present. Dimensions and specifications are correct. All the components are installed and connected correctly.	<input type="checkbox"/>
6	The installation environmental conditions are within the allowable range.	<input type="checkbox"/>
7	The mounting surfaces of the equipment on the user side and the motor have been cleaned.	<input type="checkbox"/>
8	The mounting surface has not been corroded.	<input type="checkbox"/>
9	The mounting dimensions of the equipment on the user side (such as shaft diameter, shaft length, and radial runout) comply with the specifications.	<input type="checkbox"/>
10	The braking torque of the motor comply with related requirements and actual load on site.	<input type="checkbox"/>
11	When the motor is connected to the reducer, the mounting dimensions of the reducer comply with the motor specifications.	<input type="checkbox"/>
12	A protective cover has been installed to prevent contact with the motor shaft during operation.	<input type="checkbox"/>

5.3 Installing the Motor

Installation Direction

The MS1 series motor is flange-mounted. It can be mounted in three directions, as shown in the following figure.

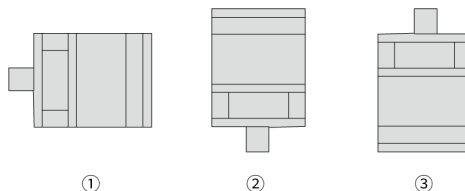

The motor can be horizontally or vertically mounted. When adopting the mechanical structure ③:

- Note the permissible axial force of the motor (gravity of the drive unit) and the IP rating requirement.
- Install the output shaft upwards to prevent intrusion of the oil into the motor.
- Ensure that the direction is suitable for operation conditions.

Heat dissipation

The MS1 series motor is naturally cooled. The internal heat is consumed through heat conduction, heat radiation and natural convection. A heatsink is used for heat conduction. For details, see "[Installation instructions](#)" on [page 28](#). To ensure adequate heat dissipation, reserve a clearance of at least 100 mm among adjacent parts on three sides.

When the motor is used together with a reducer, the motor needs to be derated.

Installation instructions

The mechanical and electrical installation of the motor must be performed by trained professionals:

- Obey the data on the nameplate and the warning labels attached to the motor.
- Ensure that the environmental conditions of the installation site (such as temperature and installation height) meet the requirements. It is forbidden to use the motor in explosive environment.
- Thoroughly remove the preservative from the shaft extension with a commonly used solvent.
- To ensure heat dissipation, install a heatsink between the machine tool and the motor. The larger the heatsink, the better the heat dissipation effect will be. The recommended size and material of the heatsink are as follows:

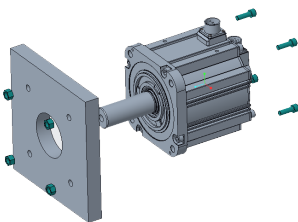

- MS1H1/MS1H4: 250 x 250 x 6 mm (aluminum)
- MS1H2-10C to 25C: 400 x 400 x 20 (mm) (steel)
- MS1H2-30C to 50C: 400 x 400 x 20 (mm) (steel)
- MS1H3-85B to 18C: 400 x 400 x 20 (mm) (steel)
- MS1H3-29C to 55C: 550 x 550 x 30 (mm) (aluminum)
- MS1H2-50CD to MS1H3-75C: 700 x 700 x 30 (mm) (aluminum)

Do not put an insulator, such as a pad, between the servo motor and heat sink, otherwise motor temperature will rise and the motor may fail.

- For vertical mounting with the shaft extension upwards, ensure that no liquid enters the upper bearing.

- When using a motor with an oil seal, you must lower the oil level to the lip of the oil seal.
- To prevent excessive wear of the oil seal, leave a small amount of oil on the lip for lubrication.
- The motor can only be installed on a flat, vibration-free and distortion-resistant support flange surface according to the specified structure.
- Use hexagon socket screws with strength grade of at least 8.8.
- When tightening the fixing screws, prevent the screws from deforming.
- Obey the recommended tightening torque values of motor flange fixing screws. See the following table "[Table 5-2 Recommended tightening torques for fixing screws](#)" on page 29.
- For motors with a flange size of 180 mm or above, remove or tighten the eyebolt after the motor is mounted.

Table 5-2 Recommended tightening torques for fixing screws

Flange Size	Screw qty and specifications	Tightening torque (N·m)
40	2xM4	2.4
60	4xM5	4.7
80	4xM6	8
100	4xM6	8
130	4xM8	20
180	4xM12	65

Note

- To avoid damage to the motor, do not hit or squeeze the shaft extension.
- To avoid corrosion,
 - When cleaning rust and stains at the end of motor shaft, use ordinary detergent.
 - Keep detergent away from the bearings and seals.
- Do not soak the oil seal in the oil. Oil inside the servo motor may cause malfunction.

Installation of the brake motor

After the brake is energized, the electric excitation coil closes and the armature is released. After the power is cut off, the brake holds the motor shaft through a mechanical elastic device. The brake is only used for stopping the motor. Frequent use will shorten its service life. If it is not absolutely necessary, do not use it for emergency stop or deceleration.

The rated voltage of the brake is 24 VDC \pm 10%. The minimum voltage that supplied on the connector at the motor side must be 24 VDC (-10%) to ensure the normal opening of the brake. When the maximum voltage (24 VDC (+10%)) is exceeded, the brake may be closed again. The voltage drop on the cable should be considered for long-distance brake cables. The approximate calculation of voltage drop ΔU of a copper cable is as follows:

$$\Delta U [V] = 0.042 \Omega \cdot \text{mm}^2/\text{m} \cdot (L / q) \cdot I_{\text{brake}}$$

Where: L = cable length (m), q = cross-sectional area of brake cable conductor (mm²), I_{brake} = Brake DC current (A)

The close time and open time of the brake vary with the discharge circuit. Ensure that the operation delay time is obtained from the actual device.

Avoid starting the motor repeatedly for a short time when the brake is still connected. Therefore, the switching time of the brake and the switching time of the relay should be considered in the drive control circuit or the enabling circuit.

For applications where the gravity shaft or mechanical parts may drop, you must take protection measures, for example, using an anti-drop mechanism with dual safety structure.

Note

- When the motor with a brake is accelerating, stopping or running at low speed, the rotating disc of the brake will produce a slight friction sound, which is not a fault or abnormality.
 - Because the brake backlash will occur when the brake is not electrified, there will be a tiny return clearance in the rotating direction of the motor shaft, which is normal.
-

Mechanical connection

Install and remove transmission units, such as couplings, gears and pulleys, only using appropriate tools.

- Use the threaded hole on the shaft extension;
- Heat the transmission unit when necessary;
- Use a washer to protect the shaft extension center during disassembly;
- The motor with a keyway has been tested for half-key balance before delivery. If necessary, you can perform full balancing for the motor with transmission units.

Coupling

- Use a dedicated flexible coupling. It is recommended to use a double leaf spring coupling that allow a certain eccentric angle.
- To prevent malfunction, use a coupling with a proper size.

- The alignment of the coupling varies with the rotating speed and the type of the coupling, ensure that the coaxiality of the loads at both ends of the coupling is < 0.03 mm.

Conveyor connection

- Select the appropriate conveyor according to the allowable radial load of the servo motor and the output power of the motor.
- When installing the conveyor, ensure that its tension is lower than the specified allowable radial load.
- See the instructions of the conveyor manufacturer for detailed installation precautions.

5.4 Post-Installation Inspection

Check the following items after installation.

Table 5-3 Post-inspection checklist

No.	Item	Checked
1	All the active and live parts have been installed, with functional test conducted.	<input type="checkbox"/>
2	The motor has been installed and aligned as specified.	<input type="checkbox"/>
3	The motor rotor can rotate freely.	<input type="checkbox"/>
4	All the anchor bolts, connectors, and electrical interfaces are fixed with specified tightening torque.	<input type="checkbox"/>
5	The actual operating conditions of the motor are consistent with those indicated on the power nameplate.	<input type="checkbox"/>
6	The drive unit has been set properly based on its type. Example: <ul style="list-style-type: none"> • The coupler has been aligned and balanced. • The conveyor device has been set properly during conveyor transmission. • The gear clearance and radial clearance have been adjusted properly. 	<input type="checkbox"/>
7	The brake has been released under the operating voltage.	<input type="checkbox"/>
8	The brake can be released and closed normally.	<input type="checkbox"/>
9	Terminal screws are tightened based on the specified torque and marked properly.	<input type="checkbox"/>
10	The servo motor is installed properly. The motor shaft is connected to the machine securely.	<input type="checkbox"/>
11	The servo motor and the machine it is connected to are in good condition and ready to run.	<input type="checkbox"/>
12	The main circuit cable lug is crimped and installed properly.	<input type="checkbox"/>

Note

- The motor can only work together with the servo drive configured.
 - The electrostatic-sensitive parts may be damaged by electrostatic discharge.
 - Take protective measures against electrostatic discharge.
 - Wear protective devices before touching the terminals of electrostatic-sensitive parts.
 - Observe related EMC instructions.
-

6 Electrical Installation

6.1 Safety Precautions

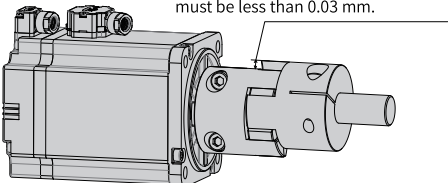
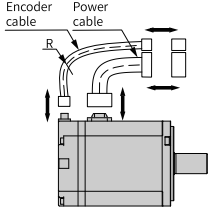
Item	Description				
Alignment	<p>Use the coupling for mechanical connection and align the shaft center of the servo motor with the shaft center of the equipment. When installing the servo motor, make sure the alignment accuracy requirement shown in the following figure is fulfilled. Failure to comply will result in vibration that may damage the bearing and encoder.</p> <p>In the following figure, the ex-circle of half the coupling that fixed to the motor end is taken as the basis for measuring the distance from the basis to any four points of the left end of the other half coupling in peripheral direction. The difference of the maximum and minimum values measured must be below 0.03 mm.</p> <p>Measure the distance at four different positions on the circumference. The difference between the maximum and minimum measured values must be less than 0.03 mm.</p> 				
Stress of cables	<p>Do not bend or pull the cable with excessive force, especially the signal wires whose conductors are only 0.2 mm or 0.3 mm in thickness. The minimum bending radius of the cable must meet the following requirements.</p> <table border="1" data-bbox="331 991 1014 1058"> <tbody> <tr> <td data-bbox="331 991 598 1026">Regular cables</td> <td data-bbox="598 991 1014 1026">$R = 5 \times$ cross sectional area of the cable</td> </tr> <tr> <td data-bbox="331 1026 598 1058">Flexible cables</td> <td data-bbox="598 1026 1014 1058">$R = 10 \times$ cross sectional area of the cable</td> </tr> </tbody> </table> 	Regular cables	$R = 5 \times$ cross sectional area of the cable	Flexible cables	$R = 10 \times$ cross sectional area of the cable
Regular cables	$R = 5 \times$ cross sectional area of the cable				
Flexible cables	$R = 10 \times$ cross sectional area of the cable				

Item	Description
Connector	<p>Pay attention to the following precautions:</p> <ul style="list-style-type: none"> ● Ensure there are no unwanted objects such as waste or sheet metal inside the connector. ● Connect the connector to the main circuit cable side of the servo motor first, and make sure the grounding cable of the main circuit cable is connected reliably. If the connector is firstly connected to the encoder cable side, the encoder may become faulty due to the potential difference between PEs. Make sure the pins are correctly arranged during wiring. ● The connector is made of resin. Do not strike the connectors to prevent them from being damaged. ● When transporting the servo motor with motor cables connected, hold the servo motor by its body instead of cables. Failure to comply may damage the connector and the cable. ● If flexible cables are used, do not apply stress to the connector during wiring. Failure to comply may damage the connector.

6.2 Pre-wiring Inspection

Check the following items before wiring.

Table 6-1

No.	Item	Checked
1	The operator has read through the installation instructions.	<input type="checkbox"/>
2	The cable model matches the motor and servo drive.	<input type="checkbox"/>
3	The cable length matches the installation requirements.	<input type="checkbox"/>
4	The cable is intact without bare cable ends or cracked connectors.	<input type="checkbox"/>
5	The operator knows the insertion direction of the connector and the error-proof flags.	<input type="checkbox"/>
6	The wiring parts are free from conductive pollutants such as water stains and metal chippings.	<input type="checkbox"/>

Caution

An operating machine or loosely-connected parts can lead to personal injury.

- Direct connection to a three-phase power supply can damage the motor.
- Ensure that all the assembly work has been done.
- Check that there is not loosely-connected parts in the motor before switching on the motor.
- Check that all the protective covers are installed properly.

6.3 Connecting the Power Cable

- The following figure shows the wiring diagram for a terminal-type motor.

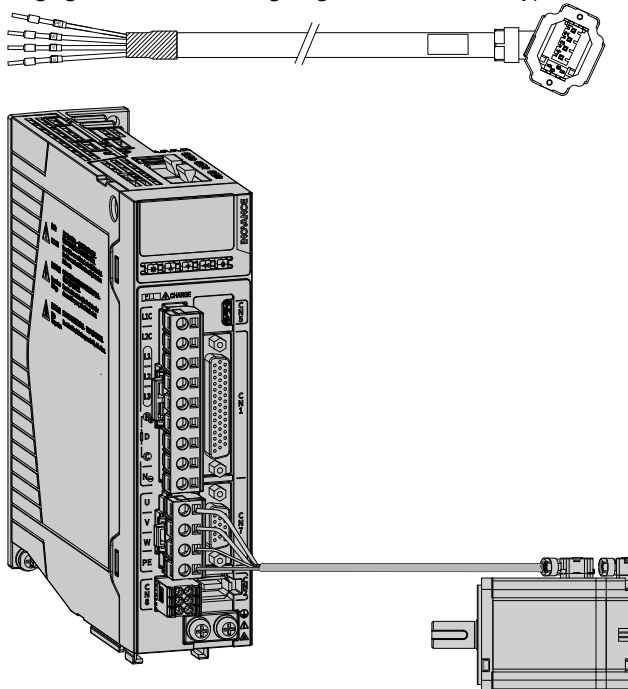
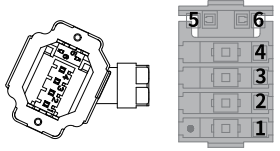

Figure 6-1 Wiring between the servo drive and terminal-type motor

The power cable of terminal-type motors supports front cable outlet or rear cable outlet. Pay attention to the cable outlet direction and the insertion direction of connectors during wiring.

Table 6-2 Power cable connector (servo motor side)

Applicable flange size [1]	Drawing	Pin layout		
		Pin No.	Signal name	Color
Terminal-type: 40 60 80	 <p>Black 6-pin connector</p>	1	PE	Yellow/Green
		2	W	Red
		3	V	Black
		4	U	White
		5	Brake (polarity insensitive)	Brown
		6		Blue

Note

- [1] The flange size refers to the width of the mounting flange (in mm).
 - Power cable colors are subject to the actual product. All cable colors mentioned in this guide refer to Inovance cable colors.
-
- The following tables describes the power cable connector for a flying leads type motor.
Pay attention to the insertion direction of connectors during connecting the flying leads type motors.

Table 6-3 Power cable connector (servo motor side)

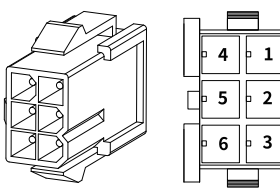
Applicable flange size [1]	Drawing	Pin layout		
		Pin No.	Signal name	Color
Flying leads type: 40 60 80	 <p>Black 6-pin connector Recommendation: Plastic housing: MOLEX-50361736 Terminal: MOLEX-39000061</p>	1	U	White
		2	V	Black
		4	W	Red
		5	PE	Yellow/Green
		3	Brake (polarity insensitive)	Brown
		6		Blue

Note

- [1] The flange size refers to the width of the mounting flange (in mm).
- Power cable colors are subject to the actual product. All cable colors mentioned in this guide refer to Inovance cable colors.

- The following table describes the connector for high-power motor power cables.

Table 6-4 Power cable connector (servo motor side)

Applicable flange size ^[1]	Drawing	Pin layout		
		Pin No.	Signal name	Color
100 130	 <p>20-18 connector</p> <p>MIL-DTL-5015 series 3108E20-18S aviation connector</p>	B	U	Blue
		I	V	Black
		F	W	Red
		G	PE	Yellow/Green
		C	Brake (polarity insensitive)	Red
		E		Black

Table 6-5 Power cable connector (servo motor side)

Applicable flange size ^[1]	Drawing	Pin layout		
		Pin No.	Signal name	Color
180	 <p>20-22 connector</p> <p>MIL-DTL-5015 series 3108E20-22S aviation connector</p>	A	U	Blue
		C	V	Black
		E	W	Red
		F	PE	Yellow/Green
		B	Brake (polarity insensitive)	Red
		D		Black

Note

- [1] The flange size refers to the width of the mounting flange (in mm).
- Power cable colors are subject to the actual product. All cable colors mentioned in this guide refer to Inovance cable colors.

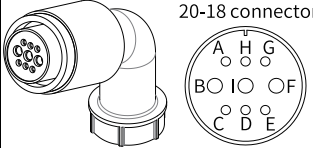
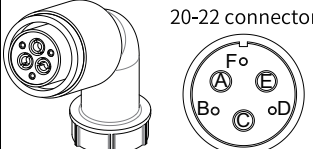
6.4 Connecting the Encoder Cable

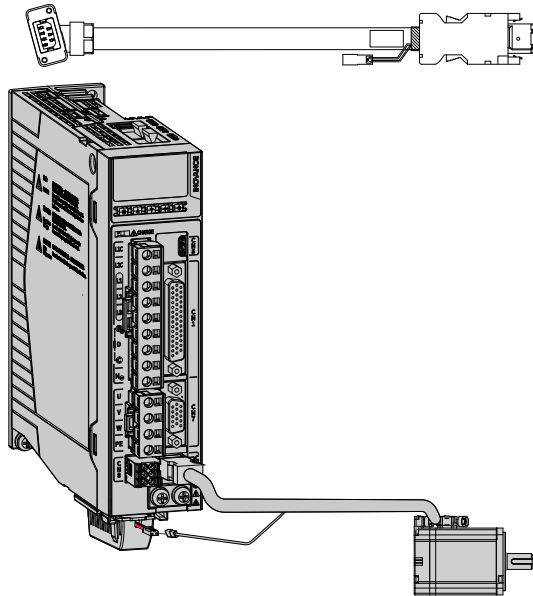

Figure 6-2 Wiring example of absolute encoder signals^[1]

Note

- [1]: The preceding figure shows the wiring of a 26-bit multi-turn absolute encoder.
- The encoder cable color is subject to the color of the actual product. Cable colors mentioned in this guide all refer to Inovance cables.

The encoder cable of terminal-type motors supports front cable outlet or rear cable outlet. Pay attention to the cable outlet direction and the insertion direction of connectors during wiring.

- **Connecting the encoder cable of terminal-type motors**

Table 6-6 Terminal-type motor encoder cable connector

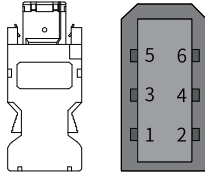
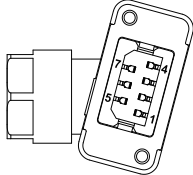
Applicable flange size [1]	Drawing		Pin layout					
			Pin No.	Signal Name	Color	Type		
Terminal-type: 40 60 80	Drive side	 <p>6-pin male (right side as the joint side)</p>	1	+5V	Red	Twisted pair		
			2	GND	Orange			
			5	PS+	Blue	Twisted pair		
			6	PS-	Purple			
			Enclosure	PE	-	-		
			Motor side	 <p>7-pin connector</p>	1	PS+	Blue	Twisted pair
					2	PS-	Purple	
	3	DC+			Brown	Twisted pair		
	4	DC-			Black			
	5	+5V			Red	Twisted pair		
	6	GND			Orange			
	7	PE			-	-		

Note

[1] The flange size refers to the width of the mounting flange (in mm).

- **Connecting the encoder cable of flying leads type motors**

Pay attention to the insertion direction of connectors during connecting the encoder cable.

Table 6-7 Flying leads type motor encoder cable connector

Applicable flange size [1]	Drawing		Pin layout			
			Pin No.	Signal name	Color	Type
Flying leads type: 40 60 80		Drive side 6-pin male (right side as the joint side)	1	+5V	Red	Twisted pair
			2	GND	Orange	
			5	PS+	Blue	Twisted pair
			6	PS-	Purple	
			Enclosure	PE	-	-
		Motor side 9-pin connector Recommended: Plastic enclosure:AMP 172161-1; Terminal: AMP 770835-1	1	Battery (+)	Brown	Twisted pair
			4	Battery (-)	Black	
			3	PS+	Blue	
			6	PS-	Purple	
			9	+5V	Red	-
8	GND		Orange			
7	Shield	-	-			

Note

[1] The flange size refers to the width of the mounting flange (in mm).

- **Connecting the encoder cable of high-power motors**

Table 6-8 High power motor encoder cable connector

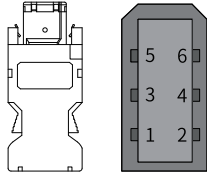
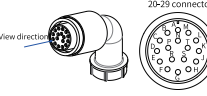
Applicable flange size [1]	Drawing		Pin layout			
			Pin No.	Signal name	Color	Type
100 130 180	 <p>Encoder cable connector</p> <p>To the connector CN2</p> <p>6-pin male (right side as the joint side)</p>	Drive side	1	+5V	Red	Twisted pair
			2	GND	Orange	
			5	PS+	Blue	Twisted pair
			6	PS-	Purple	
			Enclosure	PE	-	-
		 <p>Motor side</p> <p>20-pin connector</p> <p>View direction</p>		A	PS+	Blue
			B	PS-	Purple	
			E	Battery (+)	Brown	-
			F	Battery (-)	Black	
			G	+5V	Red	-
	H		GND	Orange		
	J	Shield	-			

Note

[1] The flange size refers to the width of the mounting flange (in mm).

- Connecting the multi-turn absolute encoder cable and battery box**

The drain wires of the multi-turn absolute encoder battery box are shown in ["Figure 6-3 Drain wire colors of the battery box" on page 41.](#)

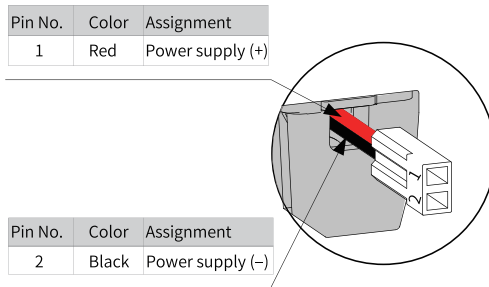

Figure 6-3 Drain wire colors of the battery box

Note

- The battery-less encoder does not need the battery kit. Connecting the battery-less encoder to the battery box can damage the encoder.
 - Keep the battery in environments within the required ambient temperature range and ensure the battery is in reliable contact and carries sufficient power capacity. Otherwise, encoder data loss may occur.
 - Model of the battery box (battery included): S6-C4A
-

Pay attention to the insertion direction of connectors during connection.

Model of the battery box (battery included): S6-C4A

- One plastic case
- One battery (3.6 V, 2,600 mAh).
- Terminal block and crimping terminal.

Keep the battery in environments within the required ambient temperature range and ensure the battery is in reliable contact and carries sufficient power capacity. Otherwise, encoder data loss may occur.

6.5 Connector Operations

Power connector

Note

Check that the connector cushion is in place before connection.

Align pins 5 and 6 with corresponding holes and insert them into the holes, as shown below. Do not insert pins 5 and 6 by force. After insertion, screw down with a tightening torque of 0.1 N·m to 0.15 N·m.

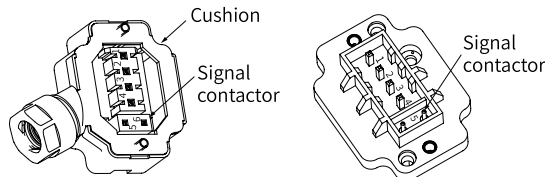

Figure 6-4 Power connector

Encoder connector

Note

Check that the connector cushion is in place before connection.

Plugs and sockets are designed with fool-proof chamfers (as shown below). Align the fool-proof chamfer before insertion. After insertion, screw down the plug screws to the panel with a tightening torque of 0.1 N·m to 0.15 N·m.

Check that the connector cushion is in place before connection.

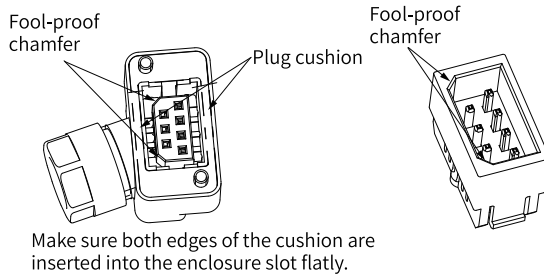

Figure 6-5 Encoder connector

Note

- The assembly direction of the connector insulator is subject to the actual direction.
- Do not energize an electrical connector connected loosely. Plug-in/out is not allowed when the power is on.
- The mating life of the electrical connector is 50 cycles. Keep the connector and socket clean without greasy dirt during use. Handle the connector and socket with care to prevent damage.
- Before connecting the male and female connectors, ensure they are free from condensation and pollutants. Take protective measures for idled connectors to prevent intrusion of dust and liquid.

Operation instructions

● Installation instructions

- The interior of the connector must be dry and clean without remanent cables or metal chippings.
- Check whether the sealing ring and sealing surface comply with the IP rating.
- Take protective measures to prevent torsion, pull-out, collision, and bending of the cables. Do not subject the connector to continuous tension.

- Do not energize an electrical connector connected loosely.
 - Plug-in/out is not allowed when the power is on.
 - The mating life of the electrical connector is 50 cycles. Ensure the joint face of the socket and plug is clean and free from greasy dirt in the whole service life. Handle with enough care during use to prevent injuries.
 - The shielded cable should be grounded on the motor and drive ends.
- **Maintenance**
 - Check whether the socket and the plug are free from condensation and dirt each time before mating.
 - When the connector is idled with its socket and plug separated, take proper measures to prevent intrusion of dust and liquid.

6.6 Post-Installation Inspection

Check the following items after installation.

Table 6-9 Post-inspection checklist

No.	Item	Checked
1	All the necessary components in the drive system are present. Dimensions and specifications are correct. All the components are installed and connected correctly.	<input type="checkbox"/>
2	The operator has read through the safety precautions of the motor.	<input type="checkbox"/>
3	The operator knows the type of the motor to be operated. Example: MS1H1-***	<input type="checkbox"/>
4	The environmental conditions are within the allowable range.	<input type="checkbox"/>
5	The actual operating conditions of the motor are consistent with those indicated on the power nameplate.	<input type="checkbox"/>
6	The minimum insulation resistance is not violated.	<input type="checkbox"/>
7	The grounding connection and equipotential connection have been established as instructed.	<input type="checkbox"/>
8	The set speed limit (nmax) is not violated during operation of the drive.	<input type="checkbox"/>
9	Connect the motor according to the specified direction of rotation.	<input type="checkbox"/>
10	All the electrical connections have been done.	<input type="checkbox"/>
11	The motor surface is not covered by thermal-sensitive or heat-insulated materials.	<input type="checkbox"/>
12	The motor must operate in the allowable voltage range only, failure to comply can lead to early abrasion. Ensure the motor operates in the allowable voltage range.	<input type="checkbox"/>
13	There are no other sources of danger.	<input type="checkbox"/>

No.	Item	Checked
14	The main circuit cables (U, V, W) of the motor are connected to the U/V/W terminals of the drive correctly.	<input type="checkbox"/>
15	The stress suffered by the cable is within the specified range.	<input type="checkbox"/>
16	The servo drive and servo motor are grounded properly.	<input type="checkbox"/>
17	All the wiring terminals are insulated properly.	<input type="checkbox"/>

 **Caution**

- Loosely-connected power interfaces may result in property loss. Excessively low tightening torque or vibration may loosen the power interfaces, which may result in fire accident, device damage, and functional fault.
 - Tighten all the power interfaces with specified tightening torque.
 - Check all the power interfaces regularly, especially after handling the motor.
-

7 Routine Maintenance

7.1 Regular Inspection

7.1.1 Regular Inspection

Table 7-1 Regular inspection checklist

No.	Inspection Item	Checked
1	The fixing screws of the connection parts between the devices are not loose.	<input type="checkbox"/>
2	There is no sign of overtemperature.	<input type="checkbox"/>
3	There is no sign of damage on the terminal block.	<input type="checkbox"/>
4	The fastening parts of the terminal block are tightened properly.	<input type="checkbox"/>

7.1.2 Regular Maintenance

Perform parts replacement based on the following table. Before replacement, contact Inovance or Inovance agent to check whether the part needs to be replaced.

Item	Type	Standard Replacement Cycle	Remark
Motor	Battery for absolute encoder	Lifetime varies depending on the conditions of use. See the user guide for the absolute encoder battery.	The standard replacement cycle is for reference only. Even if the standard replacement cycle has not expired, it needs to be replaced once an abnormality occurs.
	Insulation resistance inspection	Once per year	Measure the insulation resistance using an insulation resistance meter at 500V DC. How to measure the insulation resistance: Measure the insulation resistance between the PE (grounding terminal) and any one of U/V/W phases of the motor power cables. The insulation resistance should be higher than 10 MΩ.
Equipment	Comprehensive maintenance	At least once every 5 years or at least once every 20,000 hours, whichever comes first.	Perform in accordance with the relevant equipment maintenance guide.

8 Replacing Components



Caution

- Observe all the requirements presented in this chapter. Failure to comply may result in equipment fault or damage.
- Violent disassembly is not allowed. Take enough care during disassembly to prevent personal injury.

Standard MS1 series motors in flange sizes 60, 80, and 130 adopt C-type flat key that carries the disassembly hole. To disassemble the flat key, select a proper disassembly bolt (inner hexagon bolt recommended) based on the following table.

Specification of the key disassembly bolt		
Motor specifications	Dimensions of the flat key (unit: mm)	Specifications of the Disassembly Bolt (Inner Hexagon Bolt)
Size 60	Type-C flat key—C5×5×16.5	M3 x 10 and above
Size 80	Type-C flat key—C6×6×25	M3 x 15 and above
Size 100	Type-C flat key—C8×7×35	M3 x 20 and above
Size 130	Type-C flat key—C8×7×35	M3 x 20 and above
Size 180	Type-C flat key—C10×8×64	M3 x 20 and above

- Tool needed: an Allen wrench
- Disassembly procedure:
 1. Select a proper disassembly bolt (inner hexagon bolt recommended) based on the motor model.
 2. Use an Allen wrench to screw down the screw until the A-A end of the flat key is detached from the keyway, as shown below. See the following figure for details.

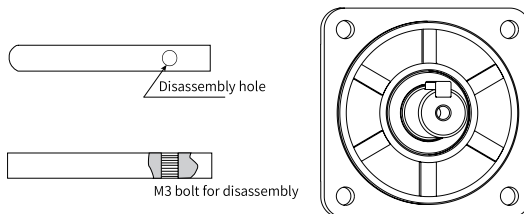

9 Appendix

9.1 Commissioning

Commissioning preparation

- Set the emergency stop function before switching on the motor to prevent accidents.
- Read the operation instructions of the servo drive in advance.
- Check that the drive and the motor are set properly.
- Rotates counterclockwise (CCW) when viewed from the shaft extension side with the forward run command.

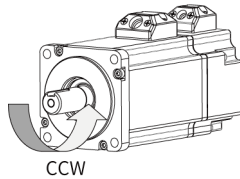

Commissioning procedure

- Start the motor through the servo drive.
- The motor must operate properly (without overload, unusual speed fluctuation, and unusual noise).
- Check the function of the safety device.
- Check whether the optimal motor parameters are reached.

Turning off the motor

Turn off the motor through the servo drive.



Danger

- Professional must follow related regulations when operating on the high-power equipment.
- Personal injury may occur when the high-power equipment is operated by non-professionals not following related regulations and requirements.
- Dangerous voltage can be generated when the motor is connected to insufficient mains power supply, which can result in death, serious personal injury, and motor damage.
- Do not touch the enclosure of the motor during operation to prevent the risk of burns.

9.2 Troubleshooting

See the solutions in "[Table 9-1 Cause/Solution](#)" on page 50 to rectify the fault. Repair or replace the damaged motor parts if necessary, or replace the whole motor.

Table 9-1 Cause/Solution

Fault	Possible cause	Solution
The motor cannot be started.	The power cable is disconnected.	Check the wiring and connect cables correctly.
	The motor protection device alarms.	Check whether protection parameters are set correctly.
	The servo drive is damaged, connected improperly, or set improperly.	Check the servo drive and set the junction box properly.
	The motor is overloaded.	Reduce the load.
The direction of rotation is wrong.	The direction of rotation is set incorrectly.	Check the parameter settings of the servo drive.
The motor accelerates slowly.	The motor is overloaded.	Reduce the load.
	The servo drive parameters are set improperly.	Check the parameter settings of the servo drive.
The brake cannot be released.	The voltage is incorrect.	Used a correct brake to connect the voltage.
	The wiring is incorrect.	Check the wiring.
	The voltage reduction on the power supply cable is higher than 10%.	Provide proper input voltage and check the cross sectional area of the cable.
The brake torque is insufficient.	The braking cushion has been worn out.	Replace the motor.
The motor is overheated during no-load operation.	The output voltage of the drive is too high and the frequency is too low.	Check the setting of the servo drive.

Fault	Possible cause	Solution
The motor is overheated during operation of the load.	The motor is overloaded.	Reduce the load.
	The motor cooling effect is affected due to obstacles.	Clean the surface of the motor to ensure good cooling effect.
The operation is unstable.	The shield of the motor cable and/or encoder cable is insufficient.	Check the shield and grounding.
	The gain values of the servo drive are too high.	Set gain values that match the servo drive.
Unusual noise is generated during operation.	The rotary parts is slippery.	Check the cause to rectify the parts.
	There are unwanted objects inside the motor.	Contact the agent or Inovance for technical support.
	The bearing is damaged.	Contact the agent or Inovance for technical support.
The radial vibration is wrong.	The rotor is unbalanced.	Contact the agent or Inovance for technical support.
The radial vibration is wrong.	The rotor is not round and the core shaft is bended.	Contact the agent or Inovance for technical support.
	The calibration is improper.	Calibrate the equipment group and check the coupler.
	The device connected is unbalanced.	Re-balance the device connected.
	The device connected is vibrating.	Check the device connected.
	The gear box operates unstably.	Make the gear box operate normally.

If the preceding measures cannot remove the faults, contact the agent or Inovance.

9.3 Disposal



- Motor disassembly must be performed or instructed by professionals.
- Dispose of the retired servo motor as general industrial waste according to local laws.
- Make necessary marks or notifications for the final product as needed.

To protect the environment, contact qualified electronics and electrical waste disposal company to recycle and handle the retired equipment according to local regulations and laws.



Copyright © Shenzhen Inovance Technology Co., Ltd.

PS00005407A02

Shenzhen Inovance Technology Co., Ltd.

www.inovance.com

Add.: Inovance Headquarters Tower, High-tech Industrial Park,
Guanlan Street, Longhua New District, Shenzhen

Tel: (0755) 2979 9595

Fax: (0755) 2961 9897

Suzhou Inovance Technology Co., Ltd.

www.inovance.com

Add.: No. 16 Youxiang Road, Yuexi Town,
Wuzhong District, Suzhou 215104, P.R. China

Tel: (0512) 6637 6666

Fax: (0512) 6285 6720