



GL20-0004ETP-2A Digital Output Module Equipment Guide



Industrial
Automation



Intelligent
Elevator



New Energy
Vehicle



Industrial
Robot



Rail
Transit



Data code PS00021939A00

Legal Information

Copyright

Copyright © 2025 Shenzhen Inovance Technology Co., Ltd. All rights reserved.

This documentation is the exclusive property of Shenzhen Inovance Technology Co., Ltd. No individual or entity may excerpt, reproduce, modify, translate, or distribute any content herein without written consent from Inovance.

Legal action will be taken against infringement.

Trademarks

INOVANCE is a registered trademark of Shenzhen Inovance Technology Co., Ltd. and its affiliates. All other trademarks or registered trademarks mentioned in this documentation are the property of their respective owners. Unauthorized use of these trademarks by third parties for any purpose without written authorization could violate the rights of their owners.

Disclaimer of Liability

Due to continuous updates and improvements of products and technologies, the content of this documentation may not fully match the actual products. In the event of any discrepancies, the actual products shall prevail.

The contents are subject to change without notice due to product upgrade.

Waste Disposal

The storage, use, and disposal of this product (including optional accessories) must comply with local laws and regulations.

Qualified Personnel

The product/system described in this documentation may be operated only by personnel qualified for the specific task in accordance with the relevant documentation, in particular its warning notices and safety instructions. Qualified personnel can identify the risks of the product/system and prevent possible dangers.

Proper Use of the Product

Proper transportation, storage, assembly, installation, commissioning, operation, and maintenance are required to ensure the safe operation of the product without any problems. The required ambient conditions must be met. All operations must follow the guidelines provided in this documentation.

Preface

Introduction

This guide includes the product overview, model and nameplate, components, terminal wiring, as well as technical and environmental specifications of the module.

Target audience

This guide is primarily intended for the following engineers:

- Business development/Service engineers of Inovance
- Chief technical engineers of channel partners/end users
- Mechanical engineers of channel partners/end users
- Electrical engineers of channel partners/end users
- Software engineers of channel partners/end users
- Maintenance/Service engineers of channel partners/end users

Documentation guide

The product documentation package is organized into equipment guide, system guide and iFA information system guide, enabling you to quickly access the information as needed.

- Equipment guide: Contains a brief description of module properties, including model, components, technical specifications, and terminal wiring diagrams.
- System guide: Covers all typical application scenarios of the system, encompassing system introduction, installation, wiring, configuration and commissioning, troubleshooting, and maintenance.
- iFA information system guide: Covers iFA software basics, product configuration for programming, instruction examples, and fault code explanations.

Standards compliance

The following table lists the certifications, directives, and standards that the product may comply with. For details about the acquired certificates, see the certification marks on the product nameplate.

Certification	Directive		Standard
CE certification	EMC directive	2014/30/EU	24 VDC products: EN 61131-2 220 VAC products: EN 61131-2 EN 61000-3-2 EN 61000-3-3
	LVD directive	2014/35/EU	EN 61010-1 EN 61010-2-201
	RoHS directive	2011/65/EU amended by (EU)2015/863	EN IEC 63000
UL/cUL certification	-		UL 61010-1 UL 61010-2-201 CAN/CSA-C22.2 No. 61010-1 CSA C22.2 NO. 61010-2-201
KCC certification	-		-
EAC certification	-		-
UKCA certification	Safety regulations	Electrical Equipment (Safety) Regulations 2016	EN 61010-1 EN 61010-2-201
	EMC regulations	Electromagnetic Compatibility Regulations 2016	24 VDC products: EN 61131-2 220 VAC products: EN 61131-2 EN 61000-3-2 EN 61000-3-3
	RoHS regulations	Directive (RoHS) Regulations 2012	EN IEC 63000

More documents

Document	Code	Description
GL20 Series Module System Guide	PS00022010	Covers all typical application scenarios of the system, providing detailed descriptions of system configuration, installation, wiring, commissioning, and troubleshooting.
GL20 Series Module Equipment Guide	PS00022042	Includes the product overview, model and nameplate, components, terminal wiring, as well as technical and environmental specifications of the GL20 series module.
iFA Information System Guide	-	Covers iFA software basics, product configuration for programming, instruction examples, and fault code explanations.
GL20-0004ETP-2A Digital Output Module Equipment Guide (This guide)	PS00021939	Includes the model and nameplate, components, terminal wiring, as well as technical and environmental specifications of the module.

Revision history

Date	Version	Description of change(s)
2025-12	A00	First release.

Access to the guide

This guide is not delivered with the product. You can obtain the PDF version in the following ways:

- Visit <https://www.inovance.com/global>, and choose Service&Support > Support > Documentation Download.
- Scan the QR code on the product with your smart phone.
- Scan the QR code below to install My Inovance app, where you can search for and download the guide.



Warranty

Inovance provides warranty service within the warranty period (as specified in your order) for any fault or damage that is caused by proper operation of the user. Maintenance will be charged after the warranty expires.

Even within the warranty period, maintenance will be charged for the following product damage:

- Damage caused by operations not following the instructions in the guide
- Damage caused by fire, flood, or abnormal voltage
- Damage caused by using the product for unintended functions
- Damage caused by using the product outside the specified scope
- Secondary damage caused by force majeure (natural disaster, earthquake, lightning strike)

When applicable, relevant maintenance fee will be charged according to the latest Price List of Inovance. If otherwise agreed upon, the agreed terms and conditions shall prevail.

For details, see the Warranty Card.

1 Fundamental Safety Instructions

1.1 General Safety Instructions

Safety disclaimer

1. Read through the safety instructions before installing, operating, and servicing the equipment, and comply with these instructions.
2. To ensure personal and equipment safety, observe the notes indicated on the product labels and all the safety instructions in the user guide.
3. The "CAUTION", "WARNING", and "DANGER" are only supplements to the safety instructions.
4. Use this equipment according to the designated environment requirements. Damage caused by improper use is not covered by warranty.
5. Inovance shall take no responsibility for any personal injury or property damage caused by improper use.

Safety levels and definitions



DANGER

The "DANGER" sign indicates that failure to comply with the notice will result in severe personal injuries or even death.



WARNING





The "WARNING" sign indicates that failure to comply with the notice may result in severe personal injuries or even death.





CAUTION

Indicates that failure to comply with the notice may result in minor or moderate personal injuries or equipment damage.

Unpacking	
<p>WARNING</p>	<ul style="list-style-type: none"> • Do not install the equipment if you find damage, rust, or signs of use on the equipment or accessories upon unpacking. • Do not install the equipment if you find water seepage or missing or damaged components upon unpacking. • Do not install the equipment if you find the packing list does not conform to the equipment you received.
<p>CAUTION</p>	<ul style="list-style-type: none"> • Check whether the packing is intact and whether there is damage, water seepage, dampness, and deformation before unpacking. • Unpack the package in accordance with the package sequence. Do not hit the package with force. • Check whether there is damage, rust, or scratches on the surface of the equipment and equipment accessories upon unpacking. • Check whether the package contents are consistent with the packing list after unpacking.

Storage and transportation	
 WARNING	<ul style="list-style-type: none"> • Large-scale or heavy equipment must be transported by qualified professionals using specialized hoisting equipment. Failure to comply may result in personal injury or equipment damage. • Before hoisting the equipment, ensure the equipment components such as the front cover and terminal blocks are secured firmly with screws. Loosely-connected components may fall off and result in personal injuries or equipment damage. • Never stand or stay below the equipment when the equipment is being hoisted by the hoisting equipment. • When hoisting the equipment with a steel rope, ensure the equipment is hoisted at a constant speed without suffering from vibration or shock. Do not turn the equipment over or let the equipment stay hanging in the air. Failure to comply may result in personal injuries or equipment damage.
 CAUTION	<ul style="list-style-type: none"> • Handle the equipment with care during transportation and mind your steps to prevent personal injuries or equipment damage. • When carrying the equipment with bare hands, hold the equipment casing firmly with care to prevent parts from falling. Failure to comply may result in personal injuries. • Store and transport the equipment based on the storage and transportation requirements. Failure to comply can result in equipment damage. • Do not store or transport the drive in environments with water splash, rain, direct sunlight, strong electric field, strong magnetic field, and strong vibration. • Do not store the drive for more than three months. Long-term storage requires stricter protection and necessary inspections. • Pack the drive strictly before transportation. Use a sealed box for long-distance transportation. • Never transport the drive with other device or materials that may harm or have negative impacts on the drive.
Design	
 DANGER	<ul style="list-style-type: none"> • Design a safety circuit and add an error handling program in the software to ensure the product remains in a safe state upon external power failure or product faults. • Add an external fuse or circuit breaker because the module may smoke or catch fire due to long-time overcurrent caused by operation above rated current or load short-circuit.
 WARNING	<ul style="list-style-type: none"> • When the output units such as relays or transistors in this product are damaged, the output may become uncontrollable and remain continuously ON or OFF. • The product design must comply with the overvoltage category requirements specified in the environmental specifications. The power supply must have a system-level lightning protection device, assuring that overvoltage due to lightning shock cannot be applied to the power supply input terminals, signal input terminals, or output terminals, preventing equipment damage. • Make sure that measures have been taken to avoid malfunction caused by the communication faults between the product and related equipment, preventing personal injury or equipment damage.
 CAUTION	<p>Do not create, on the touch screen of the HMI, switches that may result in personal injury of the operator or equipment damage . Use independent switches for performing critical operations. Failure to comply may result in accidents caused by wrong outputs or faults.</p>

Installation	
 DANGER	<p>The equipment must be operated only by professionals with electrical knowledge. Non-professionals are not allowed.</p>
 WARNING	<ul style="list-style-type: none">• Read through the guide and safety instructions before installation.• Do not install this equipment in places with strong electric or magnetic fields.• Before installation, ensure that the mechanical strength of the installation site can bear the weight of the equipment. Failure to comply will result in mechanical hazards.• Before installation, ensure that the installation environment meets the specifications. Failure to comply will result in product damage.• Do not wear loose clothes or accessories during installation. Failure to comply may result in an electric shock.• When installing the equipment in a closed environment (such as a cabinet or casing), use a cooling device (such as a fan or air conditioner) to cool the environment down to the required temperature. Failure to comply may result in equipment over-temperature or a fire.• Do not retrofit the equipment.• Do not fiddle with the bolts used to fix equipment components or the bolts marked in red.• The equipment shall be installed in a cabinet or terminal device. Protection measures such as a fireproofing shell, electric protection shell, or mechanical protection shell must be provided for the cabinet or terminal device. The IP level must meet IEC standards and local laws and regulations.• Before installing devices with strong electromagnetic interference, such as a transformer, install a shielding device for the equipment to prevent malfunction.• Install the equipment onto an incombustible object such as a metal. Keep the equipment away from combustible objects. Failure to comply will result in a fire.• For products not supporting hot swapping, disconnect all external power supplies of the system before installing/disassembling the product. Failure to comply may result in electric shock, module fault, or malfunction.
 CAUTION	<ul style="list-style-type: none">• Cover the top of the equipment with a piece of cloth or paper during installation. This is to prevent unwanted objects such as metal chippings, oil, and water from falling into the equipment and causing faults. After installation, remove the cloth or paper on the top of the equipment to prevent over-temperature caused by poor ventilation due to blocked ventilation holes.• During installation, ensure the product is connected to the respective connector securely and hook the module firmly. Improper installation may result in malfunction, fault, or fall-off.

Wiring



- The equipment must be operated only by professionals with electrical knowledge. Non-professionals are not allowed.
- Before wiring, cut off all the power supplies of the equipment. Wait for at least the time designated on the equipment warning label before further operations because residual voltage still exists after power-off. After waiting for the designated time, measure the DC voltage in the main circuit to ensure the DC voltage is within the safe voltage range. Failure to comply can result in an electric shock.
- Do not perform wiring, remove the equipment cover, or touch the circuit board with power on. Failure to comply can result in an electric shock.
- Check that the equipment is grounded properly. Failure to comply can result in electric shock. Separate grounding or single-point grounding, other than common grounding, is recommended.

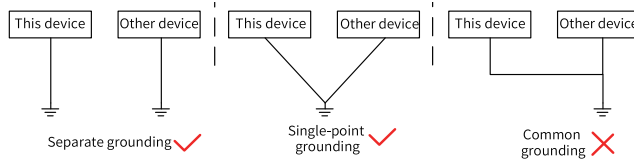

- Perform good insulation on terminals so that insulation distance between cables will not reduce after cables are connected to terminals. Failure to comply may result in electric shock or damage to the equipment.
- Install the terminal cover attached to the product before power-on or operation after wiring is completed. Failure to comply may result in electric shock.



- Do not connect the input power supply to the output end of the equipment. Failure to comply will result in equipment damage or even a fire.
- Cables used for wiring must meet cross-sectional area and shielding requirements. The shield of the cable must be reliably grounded at one end.
- Fix the terminal screws with the tightening torque specified in the user guide. Improper tightening torque may overheat or damage the connecting part, resulting in a fire.
- After wiring is done, check that all cables are connected properly and no screws, washers or exposed cables are left inside the equipment. Failure to comply may result in electric shock or equipment damage.













- Follow the proper electrostatic discharge (ESD) procedure and wear an anti-static wrist strap to perform wiring. Failure to comply may result in damage to the equipment or to the internal circuit of the product.
- Use shielded twisted pairs for the control circuit. Connect the shield to the grounding terminal of the equipment for grounding purpose. Failure to comply will result in equipment malfunction.

Power-on



- The equipment must be operated only by professionals with electrical knowledge. Non-professionals are not allowed.
- Before power-on, check that the equipment is installed and wired properly.
- Check that the power supply meets equipment requirements before power-on to prevent equipment damage or a fire.
- After power-on, do not open the cabinet door or protective cover of the equipment, touch any terminal, or disassemble any unit or component of the equipment. Failure to comply may result in death or personal injury.

Power-on
<p> WARNING</p> <p>Perform a trial run after wiring to ensure the equipment operates safely. Failure to comply may result in personal injuries or equipment damage.</p>
Operation
<p> DANGER</p> <ul style="list-style-type: none"> • The equipment must be operated only by professionals. Failure to comply will result in death or personal injury. • Do not touch any connecting terminals or disassemble any unit or component of the equipment during operation. Failure to comply will result in an electric shock.
<p> WARNING</p> <ul style="list-style-type: none"> • Do not touch the equipment enclosure, fan, or resistor with bare hands. Failure to comply may result in personal injury. • Prevent metal or other objects from falling into the equipment during operation. Failure to comply may result in a fire or equipment damage. • During operation, do not bring live parts into contact with the metal enclosure of the product. Failure to comply may result in a fire or equipment damage.
<p> CAUTION</p> <ul style="list-style-type: none"> • Operate the product strictly within the required environmental conditions. Failure to comply may result in equipment fault or damage. • Touch the HMI panel with hands only during use. Do not use tools to touch the HMI panel. Invoiance assumes no responsibility for panel damage caused by excessive external force. <p>Safety recommendations</p> <ul style="list-style-type: none"> • In the position where the operator directly touches the machinery part, for example, where a machinery tool is loaded/unloaded, or where a machine runs automatically, manually-operated devices or similar must be installed independently of the product to start or stop the automatic operation of the system. • If you need to modify the program while the system is running, use the lock function or other protective measures. Ensure that only authorized personnel can make the necessary modifications.
Battery usage
<p> WARNING</p> <ul style="list-style-type: none"> • Do not use batteries that do not meet the product requirements. Failure to comply may result in death, personal injuries, explosion, or fire. • Do not throw batteries into a fire or heat oven. Do not crush or cut the battery. Failure to comply may result in death, personal injuries, explosion, or fire. • Do not expose the battery to extremely high temperatures. Failure to comply may result in death, personal injuries, explosion, or fire. • Do not swallow the battery to prevent the risk of chemical burns. • If a button battery is swallowed by accident, seek medical treatment immediately. Failure to comply may result in severe internal burns within two hours and could result in death.
<p> CAUTION</p> <ul style="list-style-type: none"> • Keep the battery away from children. • If the battery compartment is not shut tight, stop using the device and keep it away from children.

Maintenance
<p> DANGER</p> <ul style="list-style-type: none"> • Maintenance and inspection must be carried out by personnel who have the necessary electrical training and experience. • Do not maintain the equipment with power ON. Failure to comply will result in an electric shock. • Before maintenance, cut off all the power supplies of the equipment and wait for at least the time designated on the equipment warning label. • Disconnect all external power supplies of the system before cleaning the product or re-tightening screws on the terminal block or screws of the connector. Failure to comply may result in electric shock. • Disconnect all external power supplies of the system before removing the product or connecting/removing wirings. Failure to comply may result in electric shock or malfunction.
<p> WARNING</p> <p>Perform routine and periodic inspection and maintenance on the equipment according to maintenance requirements and keep a maintenance record.</p>
Repair
<p> DANGER</p> <ul style="list-style-type: none"> • Product repair must be carried out by personnel who have the necessary electrical training and experience. • Do not repair the equipment with power ON. Failure to comply can result in an electric shock. • Before inspection and repair, cut off all the power supplies of the equipment and wait for at least the time designated on the equipment warning label.
<p> WARNING</p> <ul style="list-style-type: none"> • Submit the repair request according to the warranty agreement. • When the fuse is blown or the circuit breaker or earth leakage circuit breaker (ELCB) trips, wait as specified on the product warning sign before power-on or further operations. Failure to comply may result in personal injuries, equipment damage or even death. • When the equipment is faulty or damaged, require professionals to perform troubleshooting and repair by following repair instructions and keep a repair record. • Replace quick-wear parts of the equipment according to the replacement instructions. • Do not use damaged equipment. Failure to comply may result in death, personal injuries, or severe equipment damage. • After the equipment is replaced, check the wiring and set parameters again.
Disposal
<p> WARNING</p> <ul style="list-style-type: none"> • Dispose of retired equipment in accordance with local regulations and standards. Failure to comply may result in property damage, personal injury, or even death. • Recycle retired equipment by observing industry waste disposal standards to avoid environmental pollution. • Dispose of retired batteries as industrial waste according to local laws and regulations.

Safety label

For safe equipment operation and maintenance, comply with the safety labels on the equipment. Do not damage or remove the safety labels. The following table describes the meaning of the safety labels.

To ensure safe operation, comply with equipment-related safety labels. The following table describes the meaning of the safety labels.

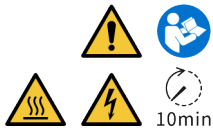
Safety label	Description
	<ul style="list-style-type: none"> • Read through the safety instructions before operating the equipment. Failure to comply may result in death, personal injuries, or equipment damage. • Do not touch the terminals or remove the cover with power ON or within 10 min after power-off. Failure to comply will result in an electric shock. • The surface of the product may become very hot during operation. Do not touch these hot areas, as this may cause burns!

1.2 Industrial Information Security

This product provides an interface to connect to the network and transmit data through the network interface. To protect factories, systems, machines, and networks from cyber attacks, appropriate industrial information security protection mechanisms need to be implemented to ensure the safe operation of factories, systems, machines, and networks.

The customer is responsible for providing and continuously ensuring a secure connection between the product and the customer's network or any other network, to prevent unauthorized access to their factory, systems, machines, and networks. The system or machine may only be connected to the corporate network or the Internet when a secure connection is established and proper security measures are in place (for example, using antivirus software and installing firewalls).

INOVANCE continuously develops and improves its products and solutions to enhance safety. It is strongly recommended that you update your products promptly and always use the latest product versions.



Malware (such as viruses, Trojans, and worms) can bring the device into an unsafe operating state, resulting in death, serious injury, and property damage. Observe the following precautions strictly:

- Always use the latest software version. If the product version is no longer supported or the latest program version is not applied, customers are at increased risk of cyberattacks.
- Implement and maintain appropriate security measures (including but not limited to deploying anti-virus software, firewall, WAF, IPS/IDS, situational awareness system, ID verification, and data encryption) to prevent files in the removable storage device from being damaged by malware and to protect products, networks, systems, and interfaces from unauthorized access, disruption, intrusion, data leakage, or information theft.
- Check all safety-related interfaces and settings after commissioning.

2 Product Overview

GL20-0004ETP-2A 4-channel high-current digital output module can be used with GL20 series communication interface modules (e.g., GL20-RTU-ECT32).

3 Model and Nameplate

Model

GL
20
- 00
04
E
TP
- 2A

①
②
③
④
⑤
⑥
⑦

① Product information GL: General local module	④ Number of I/O channels 04: 4 output channels	⑦ Current rating 2A: 2 A per channel (4 channels total)
② Series 20: 20 series module	⑤ Module type E: Logic I/O expansion module	-
③ Number of I/O channels 00: 0 input channel	⑥ Output type TP: Transistor output (source)	-

Nameplate

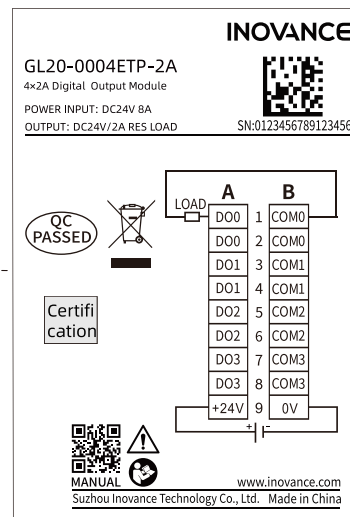





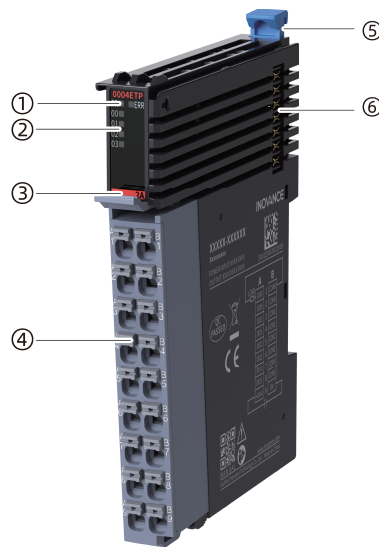

Based on the above description of model number and nameplate, the relevant ordering data of this product is described in the following table.

Model	Description	Product code	Applicable model
GL20-0004ETP-2A-INT	GL20 series 4-channel high-current digital PNP output module	01441059	Applicable to GL20 series communication interface modules (e.g., GL20-RTU-ECT32)

4 Components



No.	Interface name	Function			
①	Signal indicator	PR (POWER +RUN)	Power/Operation indicator	Yellow-green	<ul style="list-style-type: none"> • Steady ON: The module is in normal operation. • Fast flashing: The module is addressed successfully. • Slow flashing: The module is powered on but not addressed. • OFF: The module is not powered on or is faulty.
		ERR	Fault indicator	Red	Module fault
②	I/O signal indicator	00 to 03	I/O signal indicator	Yellow-green	<ul style="list-style-type: none"> • ON: Output active • OFF: Output inactive
③	Color identification	 Red: Digital output	 Orange: Analog output		
		 Gray: Digital input	 Green: Analog input		
		 White: Communication	 Blue: Other modules		
④	Push-in terminal block	Pluggable terminal block with spring clamp wiring. The terminal block features "AB" silkscreen marking. For detailed definitions, see "5.1 Terminal Assignment" on page 15			
⑤	Rail mounting latch	Used to secure module to DIN rail			
⑥	Three-position terminal block	Used for backplane bus power supply and communication			

Note

- Fast flashing: ON for 200 ms and OFF for 200 ms (cyclic).
- Slow flashing: ON for 200 ms and OFF for 1 s (cyclic).

5 Terminal Wiring

5.1 Terminal Assignment



Left signal	Left terminal	Right terminal	Right signal
DO0	A1	B1	COM0
DO0	A2	B2	COM0
DO1	A3	B3	COM1
DO1	A4	B4	COM1
DO2	A5	B5	COM2
DO2	A6	B6	COM2
DO3	A7	B7	COM3
DO3	A8	B8	COM3
+24 V	A9	B9	0 V

See the table below for the correspondence between terminal signals and signal indicators.

Terminal signal	Signal indicator
DO0	00
DO1	01
DO2	02
DO3	03

5.2 Wiring Diagram

Wiring precautions

- Do not bundle the extension cables with power cables (high voltage and high current) that produce strong interference signals, as this may increase noise, surges, and induction effects. Separate the extension cables from the power cables and avoid cabling in parallel.
- Use the recommended cables and adapter boards for connection. It is recommended that shielded cables be used as extension cables to enhance anti-interference capacity.

- Apply single-point grounding for the shield of shielded cables and soldered cables.

The following figure shows the output wiring.

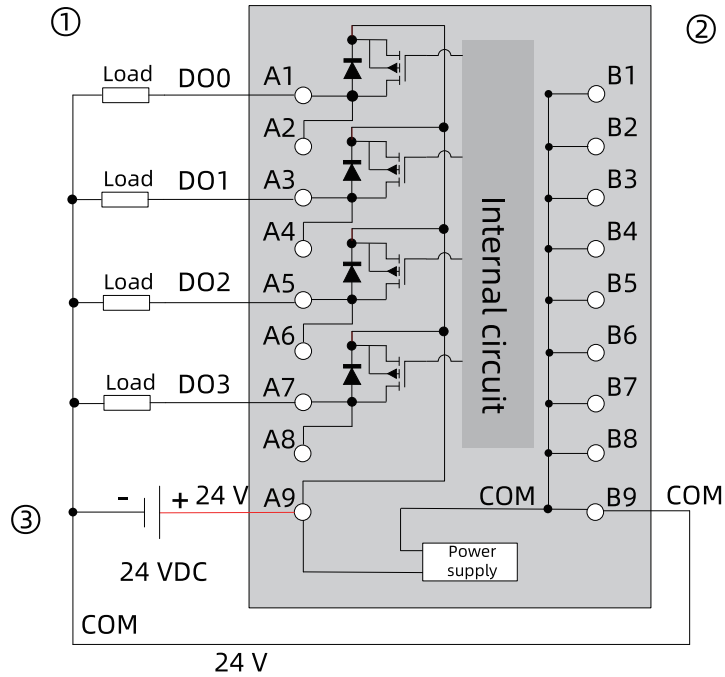

No.	Description
①	Terminals (A1 to A8) are input terminals for wiring
②	Terminals (B1 to B8) are COM terminals for wiring
③	Terminals (A9, B9) are power supply terminals for wiring

Note

- All four output channels have reserved pins (e.g., A1 and A2), with only one being used.
- All four COM channels have reserved pins (e.g., B1 and B2), with only one being used.

Caution

- The inrush current of each channel connected to a lamp load must be less than the rated current when connected to a resistive load.
- [1] Arcing and large back EMF can be generated between contacts upon stop of inductive load. Therefore, the lower the power, the greater the arc energy under the same current consumption. In this case, install an arc extinguishing device.
- For inductive loads:
 - When the circuit is DC, add a freewheeling diode. When the forward current of the flywheel diode exceeds the load current, the maximum repetitive reverse voltage is 5 to 10 times higher than the load voltage.
 - When the circuit is AC, add an RC absorption circuit, where R is 100 Ω to 200 Ω and C is about 0.1 μF.

6 Technical Specifications

Mechanical specifications

Item	Description
IP rating	IP20
Dimensions (W x H x D)	12 mm x 100 mm x 75 mm
Weight	Approx. 60 g

Power supply specifications

Item	Description
Rated bus input voltage	5 VDC (4.75 VDC to 5.25 VDC)
Rated bus input current	80 mA (typical@5 V)
Rated terminal input voltage	24 VDC (20.4 VDC to 28.8 VDC)
Rated terminal input current	8 A (typical@24 V)
Reverse polarity protection	Supported
Rated terminal output voltage	None
Rated terminal output current	None
Hot swap	Not supported

Output specifications

Item	Description
Output type	Digital output, transistor high-side output
Output mode	Source (current flows from output terminal to load)
Number of output channels	4
Output voltage class	24 VDC (20.4 VDC to 28.8 VDC)
Load resistance range	12 Ω to 4000 Ω (Modules with resistance > 4000 Ω may incorrectly report open-circuit faults. It is recommended to disable open-circuit fault diagnosis.)
Output load (resistive load)	2 A/channel; 8 A/module
Output load (inductive load)	28.8 W/channel; 57.6 W/module Note: Stopping inductive loads generates a large back EMF, which lasts for a time shorter than the configured switch-off cycle.
Output load (lamp load)	10 W/channel Note: Lamp load generates inrush current up to 10 to 15 times the normal current when switched on. This module safely drives loads with inrush current up to 10 A for $\leq 300 \mu\text{s}$.
Hardware response time (ON/OFF)	100 μs /100 μs
OFF-state leakage current	50 μA
Switching frequency	Resistive load: 100 Hz; inductive load: 0.5 Hz; lamp load: 10 Hz
Isolation	Supported
Output action display	The output indicator turns on (controlled by software) when the output is in drive state.
Output derating	Taking resistive load as an example, the module operates at full load (with the output current of all simultaneously ON output channels not exceeding 8 A) at 45°C, and operates at 62.5% of full load (with the output current not exceeding 5 A) at 55°C.

Item	Description
Protection function	<ul style="list-style-type: none"> • Short-circuit protection: Supported • Overcurrent protection: Supported • Typical overcurrent threshold: 2.8 A (2.4 A to 3.2 A) • Over-temperature protection: Supported • Overload protection: Supported
Diagnostic function	Short-circuit diagnosis, open-circuit diagnosis (SWITCH OFF/ SWITCH ON), and power supply diagnosis

Note

When there is no load and the switch is OFF, each DO interface has an output voltage within the range of 5.7 VDC to 7.8 VDC. This is normal and does not affect the functioning of the module. Such voltage disappears once a load is connected.

Software specifications

Item	Description
Output PDO data size	Max. 1 byte
Output state mode during fault stop	Output zero, last value, or preset value
Preset output value during fault stop	0 or 1
Output terminal fault detection and indication	None
Logic level configuration for output channels	Not supported
Independent channel enable configuration	Not supported
Diagnostic reporting function	Not supported
Output in the stop mode	According to output state mode during fault stop and preset output value, without further refreshing
I/O mapping	Supports bitwise, byte-wise and word-wise addressing

Note

The module stops upon fault in the following common scenarios:

- Background start/stop;
 - The bus of GL20 communication interface module is out of communication due to disconnection of the network cable or manual state switching;
 - The local bus stops operation.
-

7 Environmental Specifications

Item	Specification
Installation/Operating environment	Free from conductive dust, conductive fibers, explosive dust, flammable gases, water mist/greasy dirt, corrosive dusts/gases, strong vibration, and repetitive shock
Altitude	≤ 2000 m
Pollution degree	Level 2
Immunity	2 kV on power supply line (Conforms to IEC 61000-4-4)
Overvoltage category	I
EMC immunity level	Zone B, IEC61131-2
Anti-static rating	Contact discharge +/-6 kV and air discharge +/-8 kV
Vibration resistance	<ul style="list-style-type: none"> • Application scenario: Tested according to IEC60068-2-6. 3.5 mm amplitude at 5 Hz to 8.4 Hz; 1 g acceleration at 8.4 Hz to 200 Hz; 10 cycles per axis. • Transportation scenario: Tested according to IEC60068-2-64, 0.01 g²/Hz power spectral density at 5 Hz to 100 Hz; 0.001 g²/Hz power spectral density at 200Hz; 1.14 g G_{rms}
Shock resistance	Application/Transportation scenario: Tested according to IEC60068-2-27; 15 g peak acceleration, 11 ms pulse width, 18 shocks in total in X, Y and Z axes
Operating temperature/humidity	<ul style="list-style-type: none"> • Temperature: -20°C to +55°C • Humidity: < 95% RH (30°C), without condensation
Storage temperature/humidity	<ul style="list-style-type: none"> • Temperature: -20°C to +60°C • Humidity: < 95% RH (30°C), without condensation
Transportation temperature/humidity	<ul style="list-style-type: none"> • Temperature: -40°C to +70°C • Humidity: < 95% RH (40°C), without condensation

8 List of Spare Parts

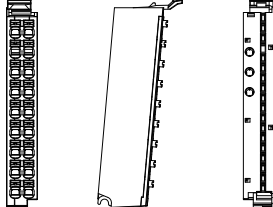
Name	Description	Product Code	Diagram
Push-in terminal block (marked as AB)	Pluggable terminal block with spring clamp wiring	15212496	

9 Dimension Drawing

The dimensions (in mm) are shown in the figure below.

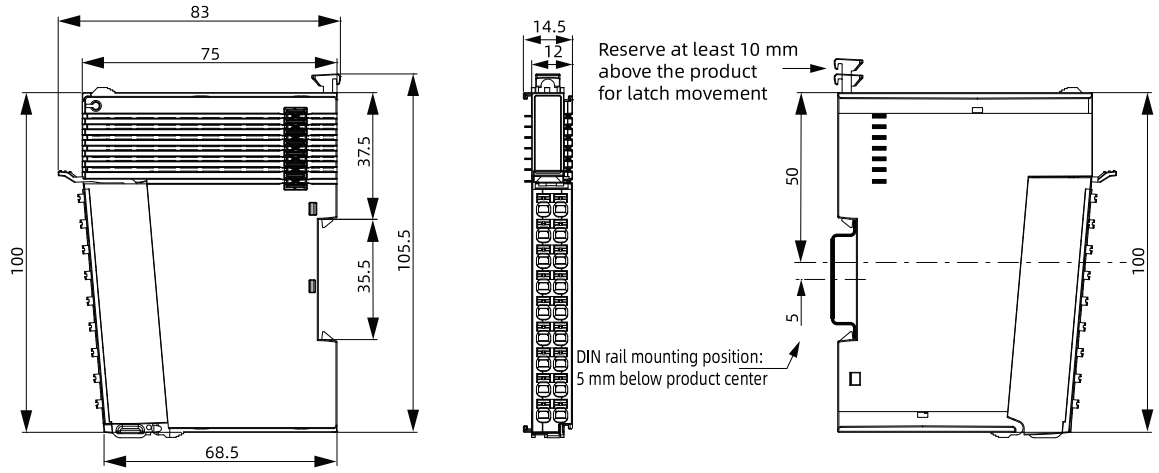

Service and Support

Should you encounter a safety accident during the use or operation of the product, or face challenges in operating and maintaining the equipment, which remain unresolved after the relevant documentation is consulted, we provide multiple channels to ensure prompt resolution:

- Channel #1: Contact service@inovance.com.
- Channel #2: Visit <https://www.inovance.com/global> to access document downloads, after-sales support, spare parts ordering, repair applications, and authenticity verification services.
- Channel #3: Download My Inovance app (<https://zshc-eu.inovance.com/download-pc/>) where you can access products info and documentation, and query product parameters.

We are committed to providing you with quick and professional technical support, and we look forward to your satisfaction and trust.



Copyright © Shenzhen Inovance Technology Co., Ltd.

PS00021939A00

Shenzhen Inovance Technology Co., Ltd.

www.inovance.com

Suzhou Inovance Technology Co., Ltd.

www.inovance.com

Add.: Inovance Headquarters Tower, High-tech Industrial Park,
Guanlan Street, Longhua New District,
Shenzhen 518000, P.R. China

Tel: (0755) 2979 9595

Fax: (0755) 2961 9897

Add.: No. 52, Tian E Dang Road, Wuzhong District, 215104,
Suzhou City, Jiangsu Province, P.R. China

Tel: (0512) 6637 6666

Fax: (0512) 6285 6720